

# UNITA' CON CONNETTORE ROTONDO A 7 PIN

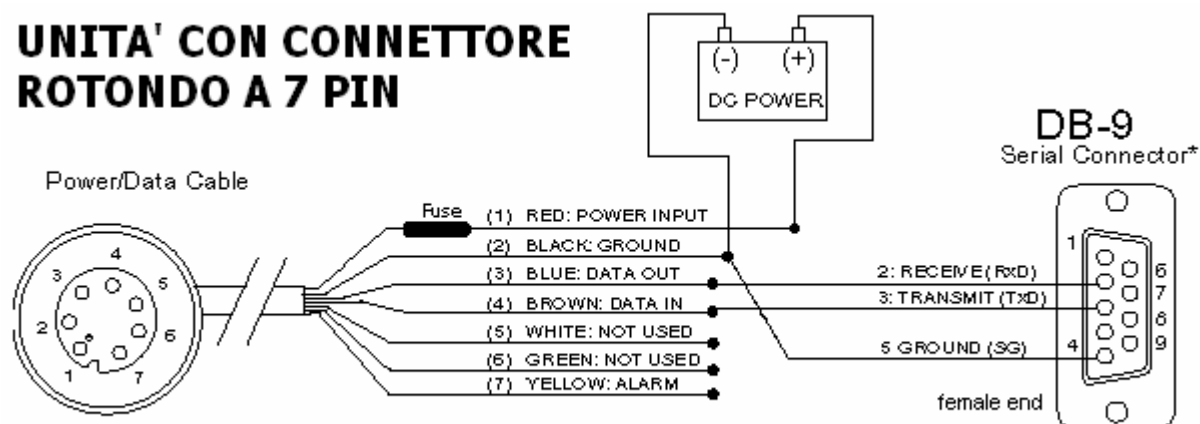

RS-232 pin out DB-9 pin used for Asynchronous Data

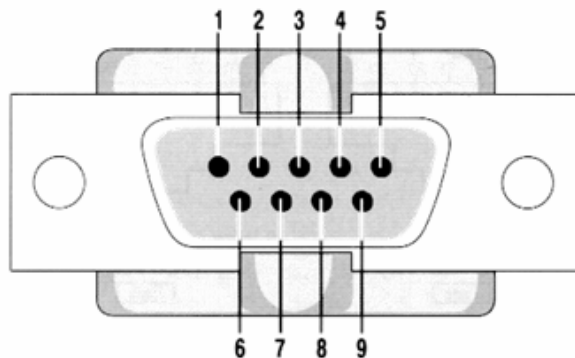

Pin	Signal	Pin	Signal
1	Data Carrier Detect	6	Data Set Ready
2	Received Data	7	Request to Send
3	Transmitted Data	8	Clear to Send
4	Data Terminal Ready	9	Ring Indicator
5	Signal Ground		